



MATERIALS

Laminated MDF top: repels dings and spills in style, available in several finishes.

Articulated steel legs: 3mm steel tubing in a coated or polished aluminum finish.

Tapered feet: tapered and adjustable, our desk feet ensure stability on any surface.

RETURN POLICY

Like-new Branch products in their original packaging can be returned for a refund within 30 days of purchase.

WARRANTY

10-year warranty. View our full policy at branchfurniture.com/pages/returns-and-warranty.

CLEANING AND CARE

Top: use a soft cloth soaked in warm, soapy water and follow with a streak-free glass cleaner.

Frame: wipe off dust with a soft cloth, and use a mild soap with water to remove stains and debris.



Quad Desk

OVERVIEW

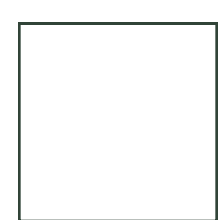

The Branch Quad Desk provides a foundation for clear thinking and inspired doing for teams of four (or more). While adding a modern touch to the open office, the classic design is complemented by robust construction. The flexible modularity allows for easy additions as you grow.

Features brushed cable ports and a central wire column for efficient organization of connectivity and cable systems.

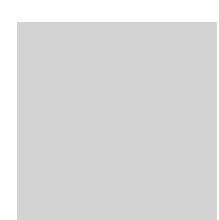
TOP COLORS

Woodgrain	White	Walnut	Fog
			
#E9D8B6	#FFFFFF	#752201	#D3D3D3

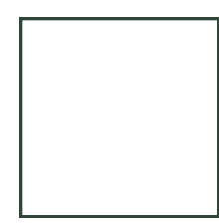
BASE COLORS

White	Charcoal	Mirror
		
#FFFFFF	#3E474B	

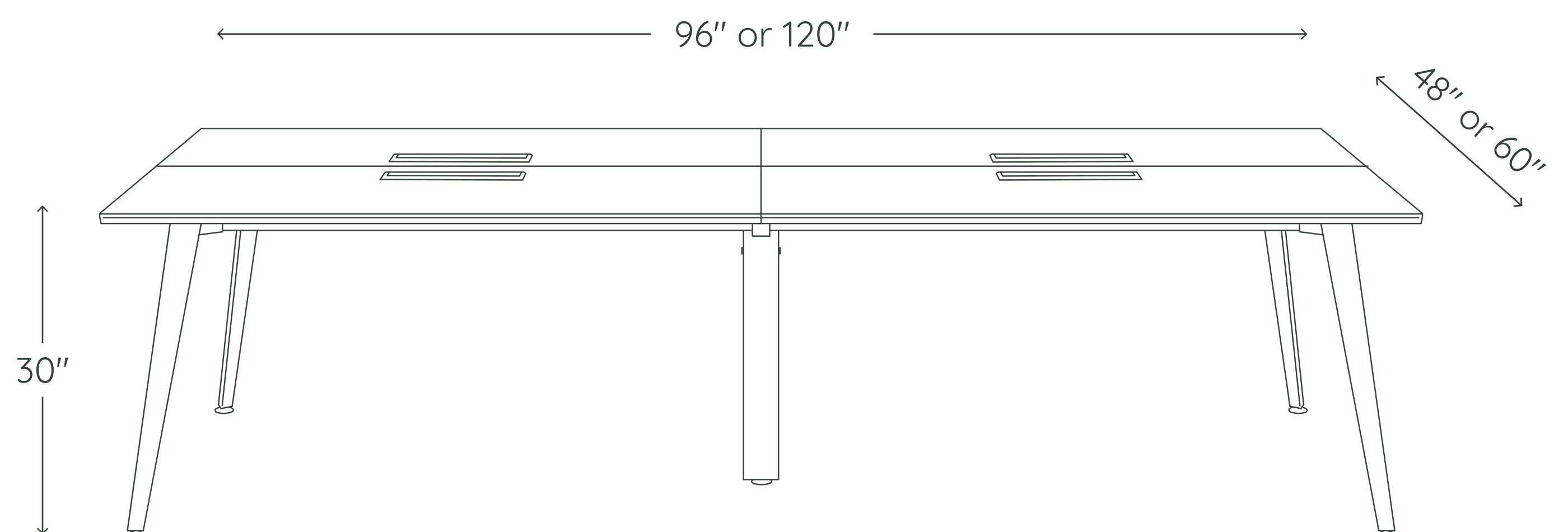

SPECIFICATIONS

Workstation size

48x24: 48"W x 24"D x 30"H

60x30: 60"W x 30"D x 30"H

Weight: 230-300 lbs

Max capacity: 650 lbs

OPTIONAL ADD ONS

